

MOUNTING AND OPERATING INSTRUCTIONS



EB 5656 EN

Translation of original instructions



Type 5656 SAM MOBILE+ Gateway

Firmware version 1.02.xx

Edition February 2026



Note on these mounting and operating instructions

These mounting and operating instructions (EB) assist you in mounting and operating the device safely. The instructions are binding for handling SAMSON devices. The images shown in this document are for illustration purposes only. The actual product may vary.

- ⇒ For the safe and proper use of these instructions, read them carefully and keep them for later reference.
- ⇒ If you have any additional questions not related to the contents of this document, contact SAMSON's After-sales Service (aftersaleservice@samsongroup.com).



Documents relating to the device, such as the mounting and operating instructions, are available on our website:

▶ <https://www.samsongroup.com/en/downloads/documentation>

Definition of signal words

⚠ DANGER

Hazardous situations which, if not avoided, will result in death or serious injury

⚠ WARNING

Hazardous situations which, if not avoided, could result in death or serious injury

ⓘ NOTICE

Property damage message or malfunction

i Note

Additional information

💡 Tip

Recommended action

1	Safety instructions and measures.....	5
1.1	Notes on possible severe personal injury.....	6
1.2	Notes on possible property damage.....	6
2	Markings on the device.....	7
2.1	Nameplate.....	7
2.2	Firmware versions.....	7
3	Design and principle of operation.....	8
3.1	Status indication.....	9
3.2	Functions.....	11
3.3	Modbus TCP communication.....	11
3.4	Technical data.....	13
3.5	Dimensions.....	14
4	Shipment and on-site transport.....	15
4.1	Accepting the delivered goods.....	15
4.2	Removing the packaging from the gateway.....	15
4.3	Transporting the gateway.....	15
4.4	Storing the gateway.....	15
5	Installation.....	16
5.1	Installation conditions.....	16
5.2	Preparation for installation.....	16
5.3	Mounting the gateway.....	16
5.4	Electrical connection.....	18
6	Start-up.....	21
6.1	Setup for use with SAMSON's SAM DISTRICT ENERGY web portal.....	21
7	Configuration.....	22
7.1	Installing SAMSON DeviceLink.....	22
7.2	Starting and updating SAMSON DeviceLink.....	22
7.3	Communication and firmware update for SAM MOBILE+ Gateway.....	22
7.4	Initialization over SAM DISTRICT ENERGY.....	23
7.5	Enabling on-site access.....	23
7.6	Resetting the gateway to default settings.....	24
8	Operation.....	25
8.1	LED status indication.....	25
9	Malfunctions.....	26
9.1	Troubleshooting.....	26
9.2	Emergency action.....	27
10	Servicing.....	28
11	Decommissioning.....	29
12	Removal.....	30
13	Repairs.....	31
13.1	Returning devices to SAMSON.....	31
14	Disposal.....	32
15	Certificates.....	33
16	Appendix.....	35
16.1	Accessories.....	35

Contents

16.2	After-sales service.....	35
------	--------------------------	----

1 Safety instructions and measures

Intended use

The gateway establishes a mobile connection to SAMSON's SAM DISTRICT ENERGY web portal.

The gateway is designed to operate under exactly defined conditions (e.g. supply voltage, temperature). Therefore, operators must ensure that the device is only used in operating conditions that meet the specifications used for sizing the device at the ordering stage.

SAMSON does not assume any liability for damage resulting from the failure to use the device for its intended purpose or for damage caused by external forces or any other external factors.

- ⇒ Refer to the technical data for limits and fields of application as well as possible uses.
- ⇒ Only operate the gateway together with supplied base.
Use the base of the Type 5655 Gateway when the gateway is delivered without a base.
- ⇒ Only install the device in rooms with restricted access and protected against public access.
Access must be restricted to authorized persons to ensure that the device is only operated for its intended purpose and complies with the applicable regulations.

Reasonably foreseeable misuse

The product (Type 5656) is not suitable for the following applications:

- Use outside the limits defined during sizing and by the technical data

Furthermore, the following activities do not comply with the intended use:

- Use of non-original spare parts
- Performing service and repair work not described

Qualifications of operating personnel

The product (Type 5656) must be mounted, started up, serviced and repaired by fully trained and qualified personnel only; the accepted industry codes and practices must be observed. According to the mounting and operating instructions, trained personnel refers to individuals who are able to judge the work they are assigned to and recognize possible hazards due to their specialized training, their knowledge and experience as well as their knowledge of the applicable standards.

Revisions and other modifications

Revisions, conversions or other modifications of the product (Type 5656) are not authorized by SAMSON. They are performed at the user's own risk and may lead to safety hazards, for example. Furthermore, the product may no longer meet the requirements for its intended use. Use of the device is no longer permitted in this case.

Warning against residual hazards

To avoid personal injury or property damage, operators and operating personnel must prevent hazards that could be caused by the device by taking appropriate precautions. Plant operators and operating personnel must observe the hazard statements, warnings and caution notes in these mounting and operating instructions.

Responsibilities of the operator

Operators are responsible for proper use and compliance with the safety regulations. Operators are obliged to provide these mounting and operating instructions to the operating personnel and to instruct them in proper operation. Furthermore, operators must ensure that operating personnel or third parties are not exposed to any danger.

Responsibilities of operating personnel

Operating personnel must read and understand these mounting and operating instructions as well as the specified hazard statements, warnings and caution notes. Furthermore, operating personnel must be familiar with the applicable health, safety and accident prevention regulations and comply with them.

Referenced standards, directives and regulations

The product (Type 5656) with a CE marking fulfills the requirements of the following Directives:

- RoHS Directive 2011/65/EU
- EMC Directive 2014/30/EU
- Low-voltage Directive 2014/35/EU
- Radio Equipment Directive 2014/53/EU

The declarations of conformity and certificates are included in Chapter 15.

Referenced documents

The following documents apply in addition to these mounting and operating instructions:

Safety instructions and measures

- ▶ EB 55xx: Mounting and operating instructions for connected components, e.g. heating controllers of the TROVIS 5500 Automation System
- ▶ EB 6901 for SAMSON's SAM DISTRICT ENERGY web portal

1.1 Notes on possible severe personal injury

⚠ DANGER

Risk of fatal injury due to electric shock.

The device (Type 5656) is designed for use in low voltage installations. Electrical connection of the device involves potential hazards.

- ⇒ Work on electrical equipment must be performed only by certified electricians.
- ⇒ Observe the relevant electrotechnical regulations of the country of use as well as the technical connection requirements of the grid operator in charge.
- ⇒ Only perform the electrical connection after disconnecting the supply voltage. Make sure the supply voltage cannot be reconnected unintentionally.
- ⇒ Only use protective equipment that can be protected against unintentional reconnection of the power supply.

1.2 Notes on possible property damage

ⓘ NOTICE

Violation of the terms of use for SAM DISTRICT ENERGY.

Use of SAMSON's SAM DISTRICT ENERGY web portal is only permitted with SIM cards registered by SAMSON.

- ⇒ Only use SAM MOBILE Gateways supplied by SAMSON or SAMSON KT-Elektronik with activated SIM cards inserted into them for connection to SAM DISTRICT ENERGY.

The use of SIM cards from third-party sources is not permitted.

ⓘ NOTICE

Unauthorized repair work will damage the gateway.

- ⇒ Do not attempt to repair the gateway yourself.
- ⇒ Send the defective gateway to SAMSON.

ⓘ NOTICE

Malfunction due to a configuration that has not yet been adapted to specific requirements.

- ⇒ Configure the gateway to match the specific requirements of the application.
- ⇒ Contact SAMSON's After-sales Service if you require support with the configuration.

2 Markings on the device

2.1 Nameplate

The nameplate shown was up to date at the time of publication of this document. The nameplate on the device may differ from the one shown.

The nameplate is located on the right side of the gateway (viewed from the front).

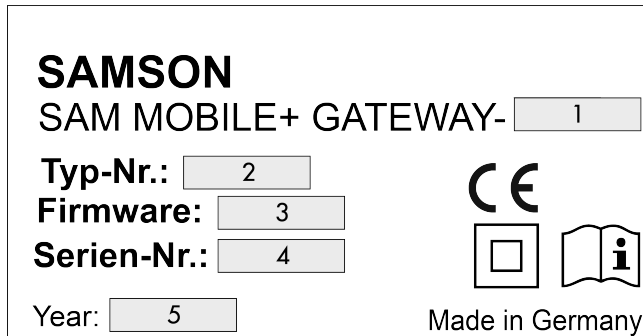

- 1 Hardware version
- 2 Type designation
- 3 Firmware version (in the delivered state)
- 4 Serial number
- 5 Date of manufacture

2.2 Firmware versions

Revisions to the SAM MOBILE+ Gateway firmware	
Old	New
1.0.x	1.01.xx
	Function to enable on-site access over SAM DISTRICT ENERGY
	Changed initialization process in default state (Delegated Regulation of Radio Equipment Directive)
1.01.xx	1.02.xx
	Configuration of analog inputs and outputs over Modbus register (in SAM DISTRICT ENERGY)
	Setting of the Modbus RTU frame formats over Modbus register (in SAM DISTRICT ENERGY)

3 Design and principle of operation

The gateway allows wireless communication with energy and utility meters, heating controllers as well as universal Modbus RTU devices connected to SAMSON's SAM DISTRICT ENERGY web portal or a Modbus TCP client using the LTE-M, NB-IoT and GPRS communication technology standard.

See Fig. 1.

The gateway must **only** be used for communication with SAMSON's SAM DISTRICT ENERGY web portal. Removal of the SIM card is not permitted. In the event of misuse, additional security features (including IMEI locking) become active and the SIM card is locked.

Do not use a third-party SIM card in the gateway for connection to SAMSON's SAM DISTRICT ENERGY web portal.

Main functions of the SAM MOBILE+ Gateway

- Remote polling of meters with an M-Bus interface (heat, electricity, water, gas)
- Remote maintenance and visualization of SAMSON TROVIS 5573, 5578, 5576, 5579 and 5578-E Controllers as well as other devices with a Modbus RTU interface
- Remote switch (floating relay output)
- Potentiometers (0 to 10 V or PWM)
- Processing of analog and digital status signals

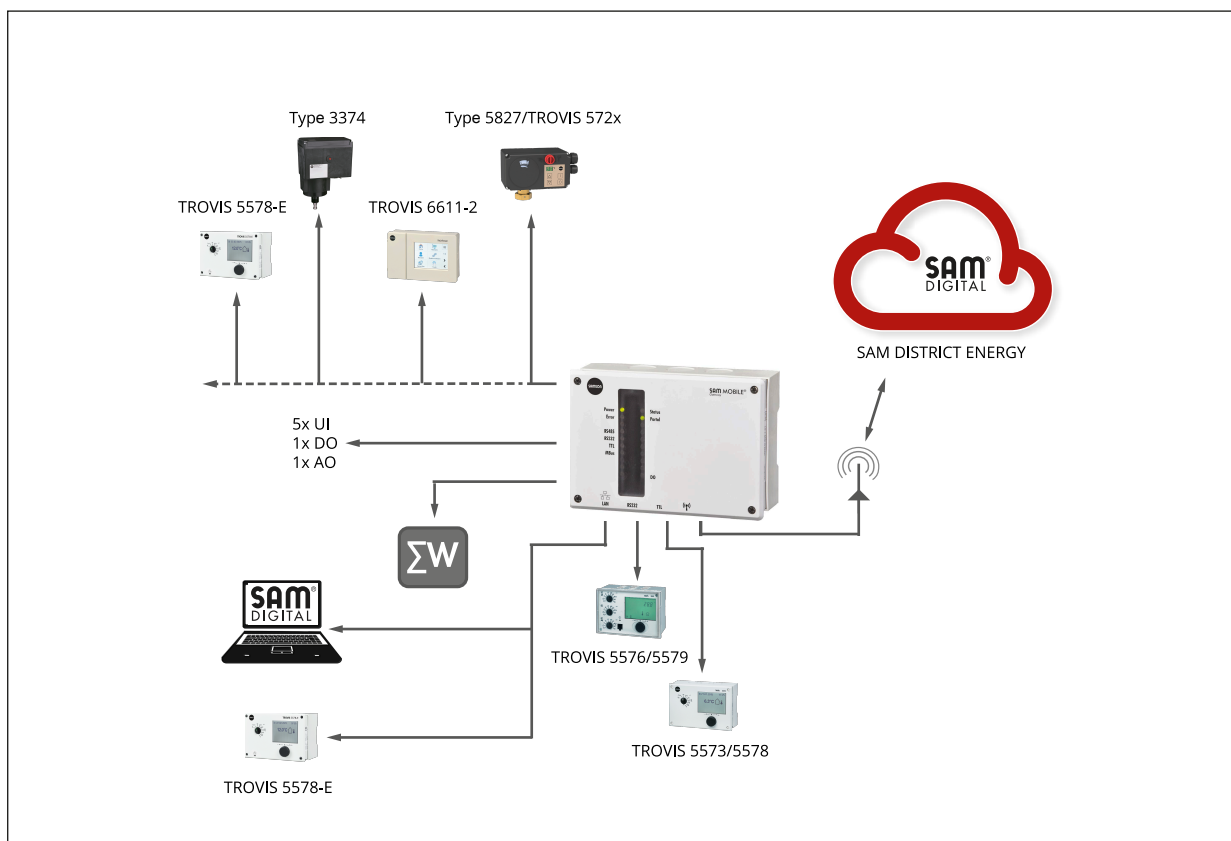

Fig. 1: Application using the SAM MOBILE+ Gateway







3.1 Status indication

The gateway has LEDs to indicate its operating and communication state. The operating states of the gateway are indicated by LEDs during start-up and servicing.



Generally, a red LED indicates errors, whereas blinking LEDs indicate restricted functioning and constantly illuminated green or yellow LEDs indicate that the gateway is functioning properly within the mobile network (see Table 1).

Design and principle of operation

Table 1: LEDs and their meaning

LED	State/blinking pattern	Meaning	Signal quality (RSRP)
Power (green)	ON	Device switched on, booting completed	-
	OFF	Device switched off/not connected	-
Status (yellow)	ON, with blinking pattern	Registered; blinking pattern indicates the signal quality as follows:	-
		Extremely poor signal, connection not possible	-140 to -125 dBm
		Very poor signal, connection probably not possible	-125 to -110 dBm
		Poor signal, likely to disconnect occasionally	-110 to -105 dBm
		Fair signal, interrupted connection not likely	-105 to -95 dBm
		Stable signal, interrupted connection not expected	-95 to -80 dBm
		Good signal, interrupted connection not expected	-80 to -65 dBm
Portal (green)	ON	Connection to SAM DISTRICT ENERGY established	-
	OFF	Not connected to SAM DISTRICT ENERGY	-
RS-485	Blinking	One green and one red LED to indicate communication on the interface. The red LED indicates data are being sent by the SAM MOBILE+ Gateway and the green LED indicates that data are being received.	-
RS-232			
TTL			
M-Bus			
DO (green)	ON	Relay contact (DO) in closed state	-
	OFF	Relay contact (DO) in open state	-
Error (red)	⇒ See Chapter 9.1.		

Legend

-  → LED long ON
-  → LED short ON

3.2 Functions

Revisions and new firmware versions are created to include new functions. A summary of the revisions is included in Chapter 2.

3.3 Modbus TCP communication

Basic function

All the SAM gateways have a new function to forward requests over Modbus TCP in addition to the usual communication based on the request and response method from Modbus TCP to Modbus RTU.

The added function makes it possible to directly connect Modbus TCP devices to the gateway and communicate with them.

This makes the following actions possible:

1. Response over internal Modbus slaves
2. Forwarding to another Modbus TCP server
3. Forwarding to Modbus RTU interfaces (UARTs) of the gateway

Modbus topology

The gateway can receive two types of TCP-based interface requests:

1. Modbus TCP server
2. SAM DISTRICT ENERGY web portal (including push mode)

Configuration of Modbus TCP forwarding using SAMSON DeviceLink

The configuration is performed using SAMSON DeviceLink. Modbus TCP devices that are accessible can be saved in the 'TCP forwarding' tab.

The SAMSON DeviceLink software can be downloaded at:

- ▶ SAMSON DeviceLink

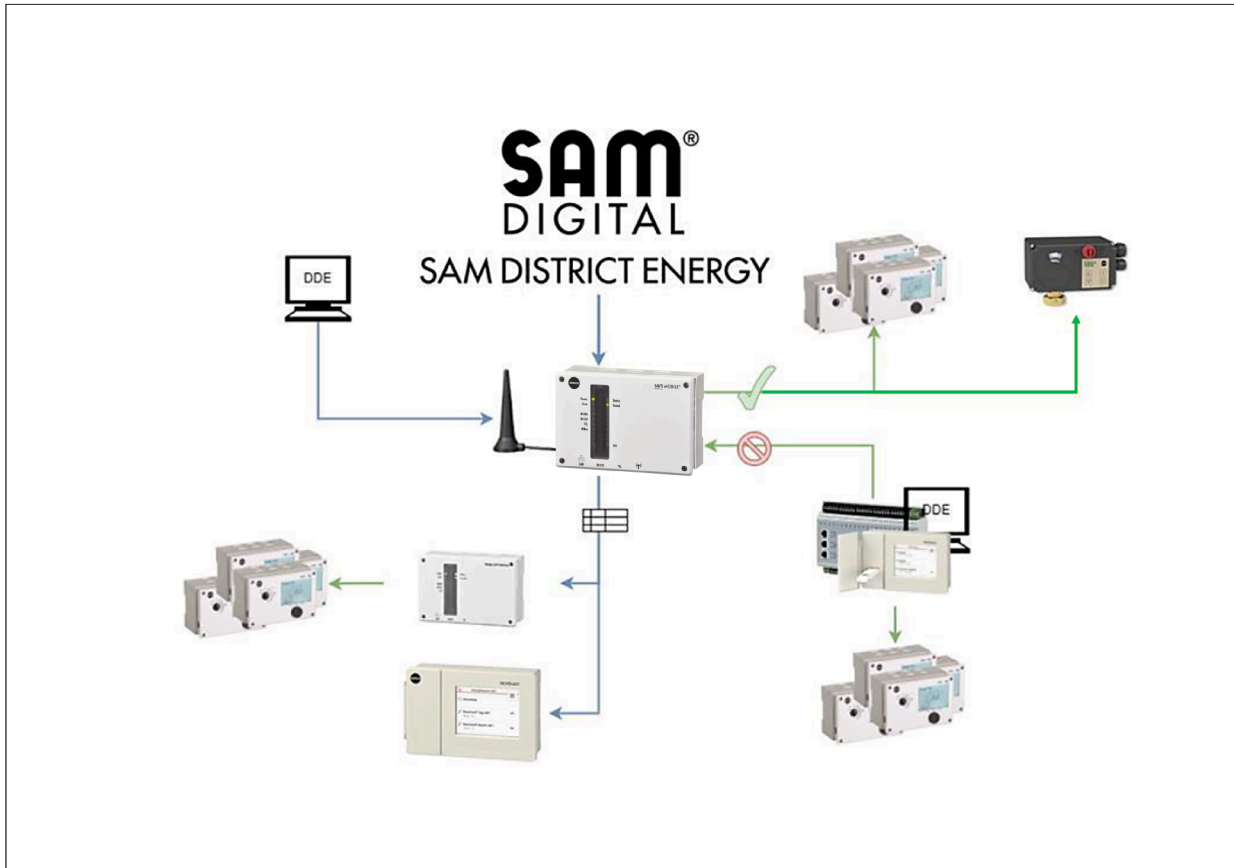





Fig. 2: Modbus communication · Structure

-  Modbus TCP (Ethernet), mobile phone network
-  Modbus RTU (TTL, RS-232, RS-485)
-  The Modbus RTU interfaces can be used either in master or slave mode. As a result, parallel use can be ruled out.
-  Requests are forwarded over Modbus TCP according to a configured table

3.4 Technical data

SAM MOBILE+ Gateway Type 5656	
Mobile network interface	SMA antenna female connector, SIM card slot (ID-000 size, 25x15 mm) Cat M1: B1/2/3/4/5/8/12/13/18/19/20/25/26/27/28/66 Cat NB2: B1/2/3/4/5/8/12/13/17/18/19/20/25/28/66 GSM 850/EGSM 900/DCS 1800/PCS 1900
LAN port (Ethernet)	IEEE 802.3, 8-pole RJ-45 port Modbus TCP protocol according to: MODBUS Messaging on TCP/IP Implementation Guide V1.0b (24.10.06), MODBUS TCP Security V21_2018-07-24 (TLS 1.2) – TLS 1.3
Controller interfaces	1x RS-485 Modbus interface for two-wire bus 1x TTL Modbus interface: RJ-45 port (8 pole), assignment according to TROVIS 5573/5578 Controller 1x RS-232 Modbus interface: RJ-45 port (8 pole), assignment according to TROVIS 5576/5579 Controller
M-Bus interface	Meter bus (two-wire), max. 3 M-Bus loads, M-Bus (mini master) according to EN 13757 (formerly EN 1434-3) or adapted
Inputs	4x 0 to 10 V, Pt1000 or DI binary input (optional) 1x Pt1000 or DI binary input (floating)
Outputs	1x floating relay output with varistor, max. load 250 V AC, 2 A 1x analog output 0 to 10 V or PWM, (175 Hz, 10 V, max. 10 mA)
Supply voltage	85 to 250 V, 48 to 62 Hz
Power line frequency	48 to 62 Hz
Power consumption	Typically 2 W
Permissible temperature ranges	
Ambient	0 to 50 °C
Storage and transport	-10 to +60 °C
Degree of protection	IP40 according to EN 60529
Class of protection	II according to EN 61140
Degree of contamination	2 according to EN 60730-1
Overvoltage category	II according to EN 60730-1
Testing standards	EN 60730-1, EN 62368-1, EN EN 61000-6-1, EN 61000-6-3, RED Directive Radio Equipment Directive 2014/53/EU, EN 301489-1, EN 300220-1
Conformity	CE
Material	PA (base, cover, housing), PA (window)
Optional additional equipment	SIM card, rod antenna, network cable (LAN) NOTICE: The Type 5656 Gateway must only be connected to SAMSON's SAM DISTRICT ENERGY web portal using the SIM card supplied by SAMSON.

3.5 Dimensions

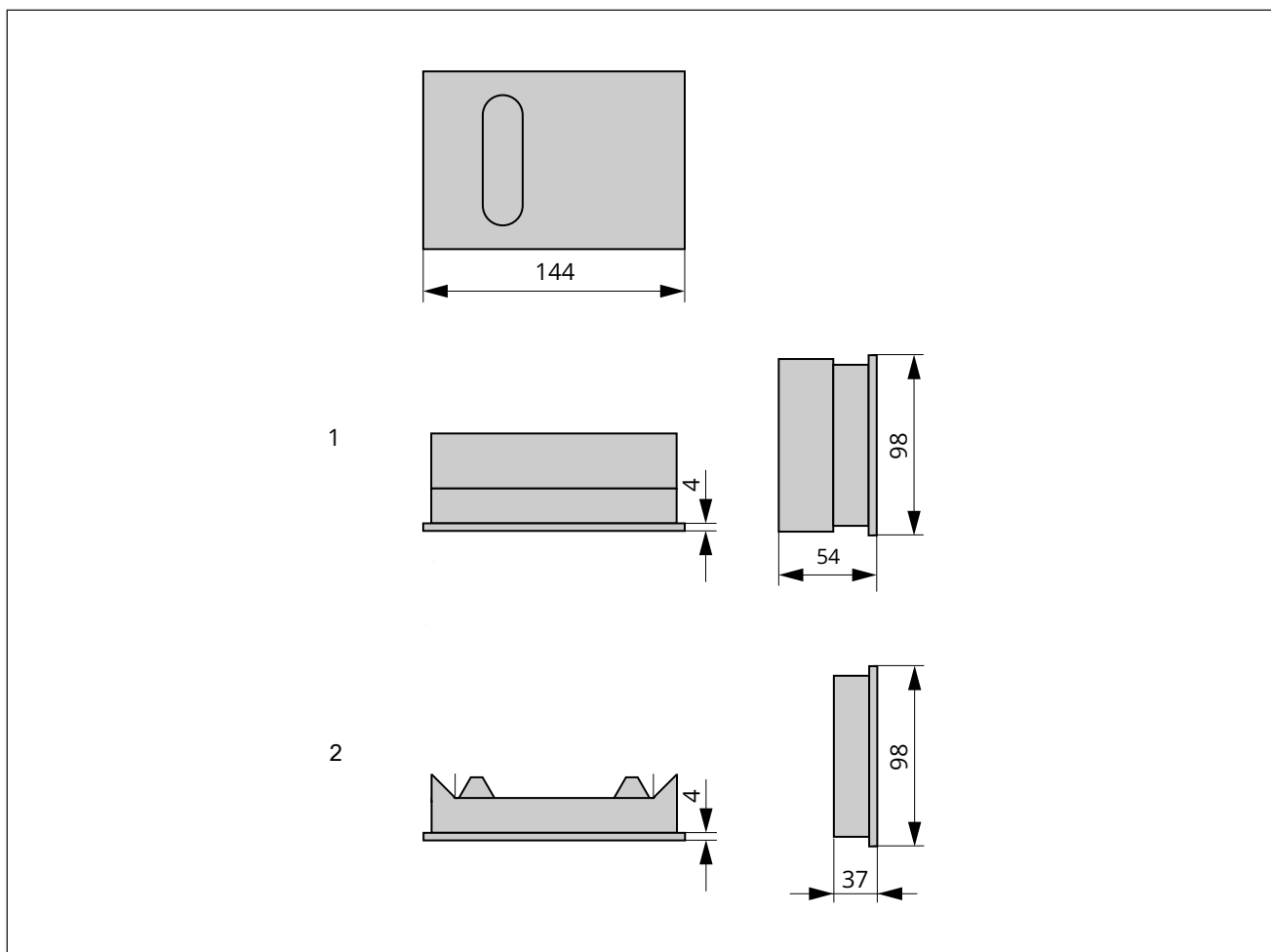

Fig. 3: Dimensions in mm · SAM MOBILE+ Gateway with and without base

- 1 Gateway with base
- 2 Gateway without base

4 Shipment and on-site transport

The work described in this chapter is to be performed only by personnel appropriately qualified to carry out such tasks.

4.1 Accepting the delivered goods

After receiving the shipment, proceed as follows:

1. Compare the shipment received with the delivery note.
2. Check the shipment for transportation damage. Report any damage to SAMSON and the forwarding agent (refer to delivery note).

4.2 Removing the packaging from the gateway

NOTICE

Risk of device damage due to foreign particles entering it.

⇒ Do not remove the packaging and protective films until immediately before mounting.

1. Remove the packaging from the device.
2. Check scope of delivery (see Table 2).
3. Dispose of the packaging in accordance with the valid regulations.

Table 2: Scope of delivery

1x Type 5656 SAM MOBILE+ Gateway with base	
	1x Document IP 5656 EN (Important Product Information)
	1x RJ-45 cable, 8-pole
	1x rod antenna
	1x SIM card
or:	
1x Type 5656 SAM MOBILE+ Gateway without base	
	1x Document IP 5656 EN (Important Product Information)

4.3 Transporting the gateway

- ⇒ Protect the device against external influences (e.g. impact).
- ⇒ Protect the device against moisture and dirt.
- ⇒ Observe the permissible transportation temperature range of -10 to +60 °C.

4.4 Storing the gateway

NOTICE

Risk of gateway damage due to incorrect storage.

- ⇒ Observe the storage instructions.
- ⇒ Avoid longer storage periods.
- ⇒ Contact SAMSON in case of different storage conditions or longer storage times.

Note

SAMSON recommends to regularly check the gateway and the prevailing storage conditions during long storage periods.

Storage instructions

- ⇒ Protect the device against external influences (e.g. impact).
- ⇒ Protect the device against moisture and dirt.
- ⇒ Make sure that the ambient air is free of acids or other corrosive media.
- ⇒ Observe the permissible storage temperature from -10 to +60 °C.
- ⇒ Do not place any objects on the device.

5 Installation

The work described in this chapter is to be performed only by personnel appropriately qualified to carry out such tasks.

5.1 Installation conditions

Work position

The work position for the gateway is the front view onto the operating controls on the gateway seen from the position of operating personnel.

Operators must ensure that, after installation of the gateway, the operating personnel can perform all necessary work safely and easily access the device from the work position.

Point of installation

The device is intended for installation in rooms (usually boiler rooms) with restricted access and protected against public access to ensure that only authorized persons can enter.

This ensures that it is operated as intended and complies with regulatory requirements.

5.2 Preparation for installation

Before installation, make sure that the following conditions are met:

- The gateway is not damaged.

Proceed as follows:

- ⇒ Lay out the necessary material and tools to have them ready during installation work.

5.3 Mounting the gateway

The gateway is suitable for panel, wall and rail mounting. On exchanging the device, the base of the Type 5655 SAM MOBILE Gateway can be used.

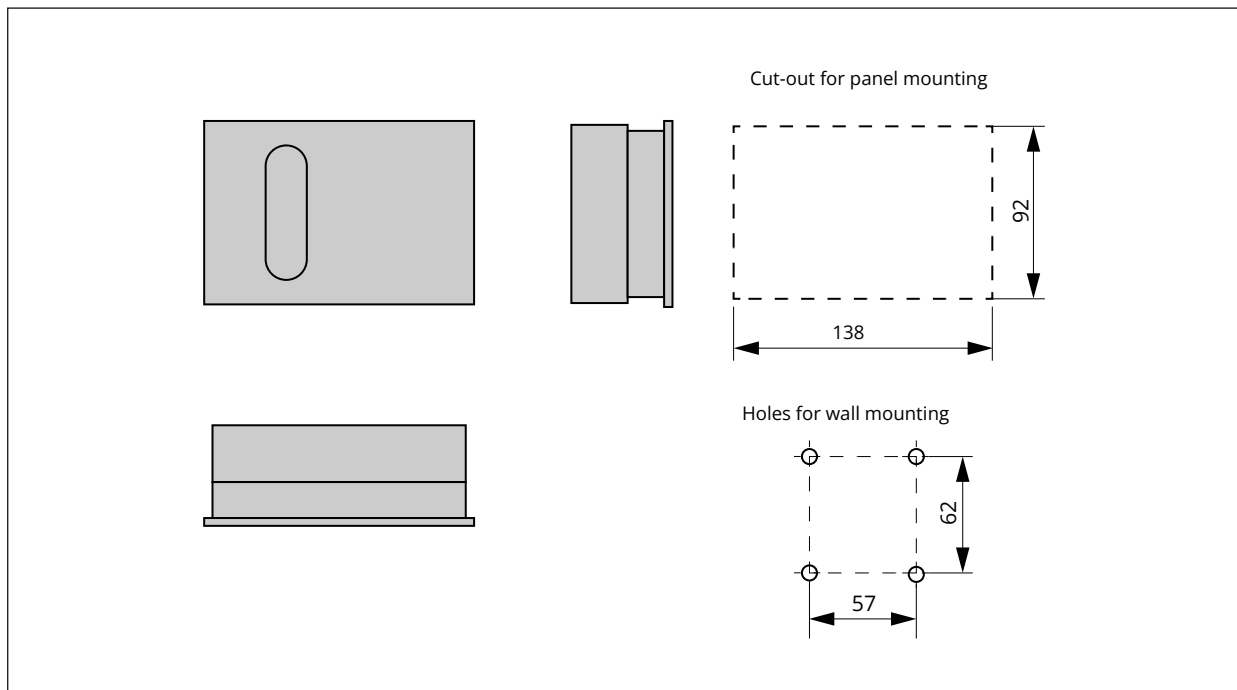

Fig. 4: Mounting the gateway

NOTICE

Activation of additional security features.

In the event of misuse, additional security features (including IMEI locking) are activated.

⇒ Do not remove the SIM card.

SAM MOBILE+ Gateway with base

Panel mounting

1. Undo the screws on the front cover.
2. Separate the gateway from the base.
3. Make a panel cut-out with the dimensions 138x92 mm (WxH).
4. Push the base through the panel cut-out.
5. Perform the electrical connection on the base according to Chapter 5.4.
6. Place the gateway onto the base.
7. Screw in the screws and tighten them.

Rail mounting

1. Fasten the spring-loaded hook at the bottom of the top hat rail.
2. Slightly push the gateway upwards and pull the top hooks over the top hat rail.
3. Undo the screws on the front cover.

4. Separate the gateway from the base.
5. Perform the electrical connection on the base according to Chapter 5.4.
6. Place the gateway onto the base.
7. Screw in the screws and tighten them.

Wall mounting

1. Undo the screws on the front cover.
2. Separate the gateway from the base.
3. If necessary, drill holes with the specified dimensions in the designated places (see Fig. 4). Fasten the base with four screws.
4. Perform the electrical connection on the base according to Chapter 5.4.
5. Place the gateway onto the base.
6. Screw in the screws and tighten them.

SAM MOBILE+ Gateway without base (on exchanging the device)

1. Disconnect the supply voltage.
2. Check the electrical connection on the mounted base.
3. Place the gateway onto the base.
4. Screw in the screws and tighten them.

5.4 Electrical connection

⚠ DANGER

Risk of fatal injury due to electric shock.

The gateway is designed for use in low-voltage installations. Electrical connection of the device involves potential hazards.

- ⇒ Upon installation of the electric cables, you are required to observe the regulations concerning low-voltage installations according to DIN VDE 0100 as well as the technical connection requirements of your local energy supplier.
- ⇒ Work on electrical equipment must be performed only by certified electricians.
- ⇒ Use a suitable voltage supply which does not allow any dangerous voltage to reach the device in normal operation or in the event of a malfunction in the system or any other system parts.
- ⇒ Only perform the electrical connection after disconnecting the supply voltage. Make sure the supply voltage cannot be reconnected unintentionally.
- ⇒ Only use protective equipment that can be protected against unintentional reconnection of the power supply.

Notes on electric wiring

- ⇒ Observe terminal assignment (see Fig. 5).
- ⇒ Install the 230 V power supply lines and the signal lines separately. To increase immunity, keep a minimum distance of 10 cm between the lines. Make sure the minimum distance is also kept when the lines are installed in a cabinet.
- ⇒ On connecting the wiring to the terminals, make sure that all accessible parts are insulated.
- ⇒ Inductances in the control cabinet, e.g. contactor coils, must be equipped with suitable interference suppressors (RC elements).
- ⇒ Control cabinet elements with high field strength, e.g. transformers or frequency converters, must be shielded with separators providing a good ground connection.

Overvoltage protection

- ⇒ If bus lines are installed outside buildings or over large distances, make sure appropriate surge or overvoltage protection measures are taken.
- ⇒ Take appropriate overvoltage protection measures for external antennas.

- ⇒ Only use shielding that has an electric current conducting capacity and is grounded at both sides to shield the bus lines.
- ⇒ Install surge diverters at the entry of the control cabinet.

The terminal compartment is located in the base of the gateway.

- ⇒ To feed through cables, break through the holes in the marked locations at the top or bottom at the base housing and fit grommets or suitable cable glands.
- ⇒ Ensure that the cables are not subject to torsion or bending by taking suitable precautions, e.g. a cable duct, before inserting the cable.

⚠ DANGER

Risk of fatal injury as a result of failing to observe the permissible touch voltage.

Separation of the circuits is absolutely essential when SELV equipment is connected to terminal 21 as this equipment has a different intended use of the supply voltage than specified in the technical data (230 V AC). The creepage and clearance present in the base and gateway do not guarantee the required dielectric strength and the safe separation of the 230 V supply voltage and the other circuits.

- ⇒ Take appropriate safety precautions (e.g. by using coupling relays for ELV fault signaling contacts).
- ⇒ Only connect 230 V equipment.

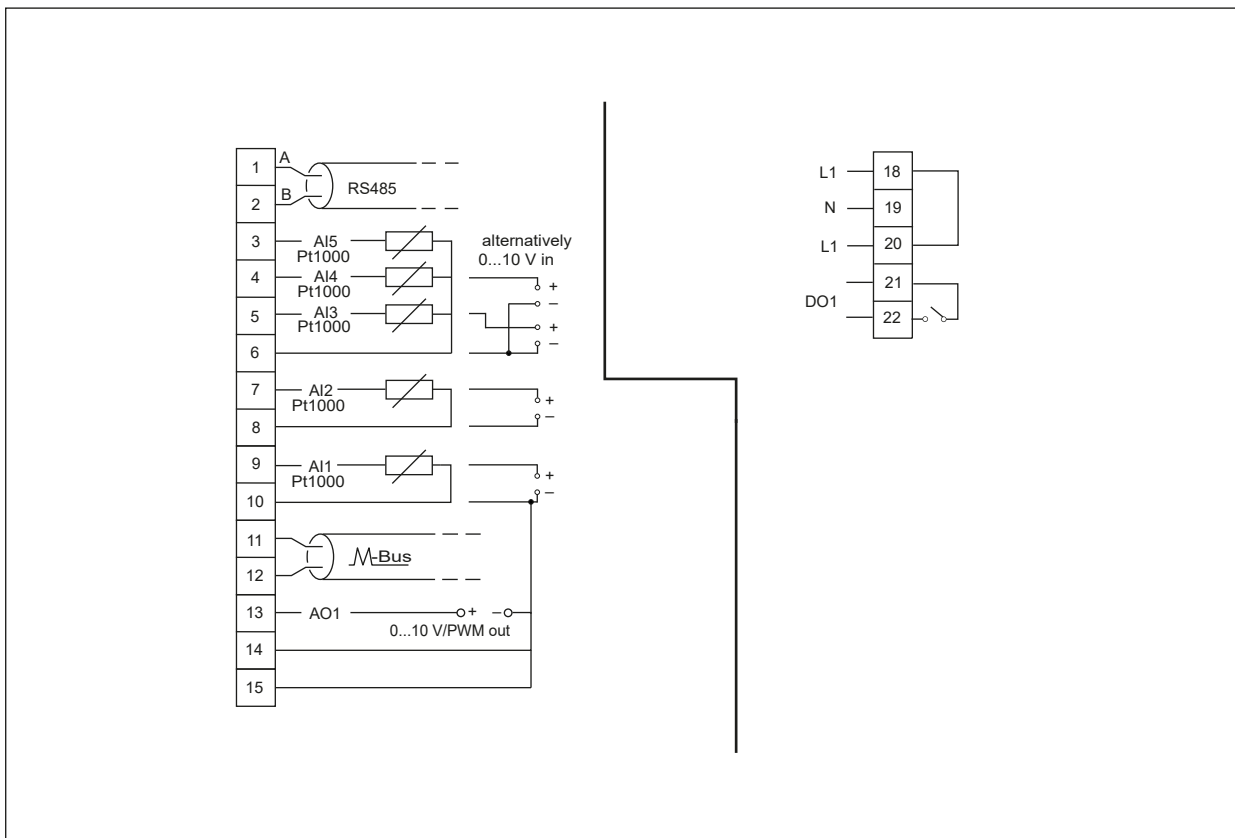

Fig. 5: Electrical connection · Type 5656

Supply voltage

⇒ Connect the supply voltage to the terminals 18 and 19 in the base of the gateway.

Controller connection RS-232

One single SAMSON TROVIS 5576 or TROVIS 5579 Controller, or alternatively another device that has an RS-232 interface, can be connected to the RS-232 port of the gateway. Do not activate the modem operation function of a connected controller.

Exception: fault alarm of a separately connected controller with the modem/controller setting (TAP-SMS).

Controller connection TTL

The TTL port is used to connect a single SAMSON TROVIS 5573 or TROVIS 5578 Controller as well as a SAMSON KT-Elektronik SOL3 or WPR3 Controller or equivalent devices. The controller is connected with an 8-pole RJ-45 cable (max. cable length: 100 cm) directly to the gateway.

Controller connection over RS-485 bus

One or more controllers or Modbus RTU devices can be connected to the terminals 1 and 2 (RS-485) of the gateway. In this case, the controllers and de-

vices must have an RS-485 interface (two-wire version) or be fitted with a corresponding converter.

i Note

The connection of more than 10 controllers to the RS-485 bus may cause the monthly data allowance limit to be exceeded. Additional costs may be incurred. Contact SAMSON's After-sales Service to avoid them.

Examples:

- Converter for TROVIS 5573/5578: iCon485 (8812-2002)
- Converter for TROVIS 5576/5579: cable converter (1400-8800)

This allows up to 40 controllers or Modbus RTU devices to be connected to a single gateway. For the sake of quick access to controller data, it is advisable not to make full use of this specification. In such cases, it is better to use several gateways.

Various RS-485 devices can be connected as part of an RS-485 network to the two-pole terminal. RS-485 network rules concerning stub lines, bus termination and bus bias voltage must be observed in this case.

Installation

Devices with RS-485 interface in four-wire versions can be used. In this case, SAMSON recommends using the CoRe02 Universal Bus Unit (article no. 11996, order no. 1402-1433). When bus hubs (1400-7140) are used in place of the CoRe02 universal bus unit to connect devices with RS-485 interface in four-wire versions, the TA wire must be jumpered to the RA wire and the TB wire jumpered to the RB wire.

Binary output (relay)

The binary output (relay) is a floating switching contact at terminals 21 and 22. Small loads can be switched using this switching output. It can also be connected to a binary input of another device.

- ⇒ A switching voltage (e.g. 230 V AC) applied to terminal 21 (e.g. using a jumper from terminal 20 (L1)).
- ⇒ Observe the permissible load of the relay specified in the technical data. A contactor must be installed in the circuit for higher loads.

M-Bus interface (meter bus)

Up to three heat, water, gas or electricity meters with an M-Bus interface can be connected at terminals 11 and 12 (M-Bus). The meter data (meter readings, momentary capacity, flow rate etc.) are available over Modbus TCP.

Inputs

The analog inputs AI1 to AI4 are designed for the direct connection of 0 to 10 V sensors or Pt1000 sensors. AI5 can only be used for a Pt1000 sensor. Alternatively, the inputs can be used as floating inputs for binary signals.

Select the analog input type in the SAMSON DeviceLink software (see Chapter 6).

– 0 to 10 V

If a (positive) DC voltage between 0 and 10 V is applied to terminals AI1 to AI4 to act in the opposite direction to the COM terminal, the measured value can be read remotely using the gateway. It is used to read a signal of another device or a 0 to 10 V sensor.

– Pt1000

If a Pt1000 sensor is connected to AI1 to AI5 and COM terminals, the gateway is able to read the temperature at the sensor and make this value available for data remote polling.

– Floating binary inputs

The AI1 to AI5 inputs can be connected as floating inputs.

Analog output

The analog output at the terminals 13 (AO1) and 14 (COM) of the device is used for direct connection of control inputs for 0 to 10 V signals or a PWM signal. It can be used for the remote control of actuators or pumps.

Network connection (LAN)

The LAN port of the gateway allows connection to a network. It can be connected using an 8-pole patch cable to a network switch, hub or Internet router. It is also possible to directly connect a computer (e.g. notebook).

The interface is also used for configuring the gateway using the SAMSON DeviceLink tool (see Chapter 6).

6 Start-up

NOTICE

Violation of the terms of use for SAM DISTRICT ENERGY.

Use of SAMSON's SAM DISTRICT ENERGY web portal is only permitted with SIM cards registered by SAMSON.

⇒ Only use SAM MOBILE Gateways supplied by SAMSON or SAMSON KT-Elektronik with activated SIM cards inserted into them for connection to SAM DISTRICT ENERGY.

The use of SIM cards from third-party sources is not permitted.

6.1 Setup for use with SAMSON's SAM DISTRICT ENERGY web portal

Gateway delivered with an activated SIM card inserted into it

The gateway is delivered with the SAMSON default configuration. This configuration allows the device to automatically connect to SAMSON's SAM DISTRICT ENERGY web portal after the supply voltage (230 V) is connected. The device needs to be registered manually. The MAC address must be known to register the device.

How to proceed:

The power LED is illuminated when the gateway is connected to the supply voltage.

Once the gateway has booted, it attempts to connect to the Internet.

LED	Status
Power	ON

The status LED indicates the mobile connection status as soon as the Internet connection is established.

As soon as the gateway is connected to the Internet, it attempts to connect to SAMSON's SAM DISTRICT ENERGY web portal.

LED	Status
Power	ON
Status	Blinking (1:1)

The portal LED is permanently illuminated once connection to SAM DISTRICT ENERGY has been established. The portal LED briefly goes out and is illuminated again to indicate that the connection to the web portal is stable.

The error LED blinks in the event of an error (see Chapter 9).

LED	Status
Power	ON
Status	Blinks according to blinking pattern (see Chapter 3.1)
Portal	ON

⇒ Log on to the SAM DISTRICT ENERGY web portal using your personal login data (► EB 6901).

⇒ Register the gateway using the MAC address of the device (visible on the housing, starting with 00:E0:99:Fx:xx:xx).

For reasons of data security, the device must be registered in the web portal within 48 hours after the device has been started.

Restarting the gateway resets this time and allows the device to be registered after a timeout.

i Note

Settings, such as the utility meter settings (primary address, readout type and cycle), can be configured directly in SAM DISTRICT ENERGY (► EB 6901). Additional settings (including settings in the expert mode) and the debugging function are performed using the SAMSON DeviceLink software. These settings can be made on a notebook and transferred afterwards to the device.

7 Configuration

7.1 Installing SAMSON DeviceLink

1. Download the SAMSON DeviceLink software at [▶ SAMSON DeviceLink](#).
2. Install the SAMSON DeviceLink software on a computer or notebook.

7.2 Starting and updating SAMSON DeviceLink

i Note

Internet connection must be established to perform an update.

After starting the program, it automatically checks whether updates are available for SAMSON DeviceLink. The 'Updates available' message indicates their availability.

The update download must be started manually. Installation is automatically completed.

Alternatively, select the 'Help' menu to search for updates.

1. Start the program.
2. Search for updates.
3. Select and install the update.

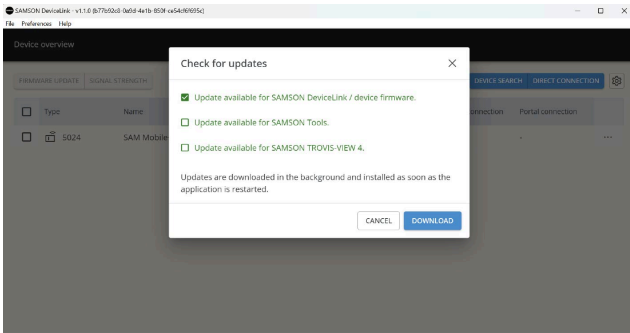

4. Restart SAMSON DeviceLink.

7.3 Communication and firmware update for SAM MOBILE+ Gateway

1. Make sure that the SAM MOBILE+ Gateway is correctly installed and the supply voltage is connected.
2. Use an Ethernet cable to connect the computer or notebook directly to the SAM MOBILE+ Gateway.

The gateway has an integrated DHCP server function.

An IP address is automatically assigned to the connected notebook. The network settings in the computer or notebook must be set accordingly for the DHCP client function (the IP address is automatically assigned). The computer/notebook and gateway now have the same address range to communicate with each other.

3. Start SAMSON DeviceLink and click the 'Device search' button.
The software searches for connected devices and lists available gateways.
4. Perform a firmware update for each single gateway or for several devices at the same time.

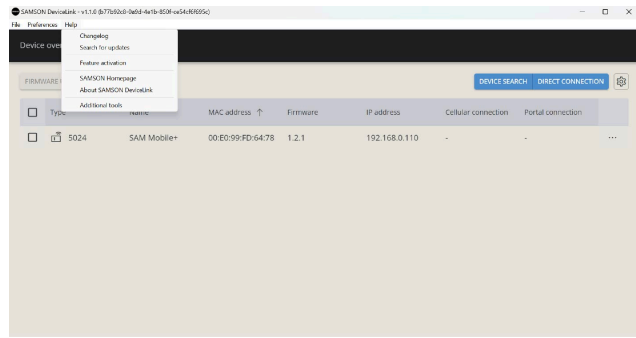

i Note

To update a device with firmware version 1.01.xx and higher, the password for enabling on-site access from SAM DISTRICT ENERGY or a customized password is required.

5. Enter the password when prompted to access the configuration, debugging and other functions.
 - ⇒ For gateways not yet registered in the SAM DISTRICT ENERGY web portal, enter the default password "Kundendienst" when prompted.
 - ⇒ For gateways already registered in the SAM DISTRICT ENERGY web portal, enable on-site access in SAM DISTRICT ENERGY (see Chapter 7.4).
6. Change the password.

i Note

To meet the requirements of Radio Equipment Directive 2014/53/EU, the password must be changed in order to use the full range of functions in SAM DISTRICT ENERGY.

7.4 Initialization over SAM DISTRICT ENERGY

The European Commission Delegated Regulation (EU) 2022/30, which supplements the Radio Equipment Directive, stipulates that a customized device password must be assigned before start-up. This regulation provides specific details on requirements concerning cybersecurity, personal data and fraud protection for internet-connected radio equipment. It applies to new products as of 2025-08-01.

The SAM MOBILE+ Gateway meets the requirements of the Directive concerning the start-up with the default settings (default password). The following aspects of this directive are implemented:

- On registering the SAM MOBILE+ Gateway using the default password in SAM DISTRICT ENERGY, a random password is automatically generated, which can only be changed at the device after enabling the on-site access (see Chapter 7.5).

i Note

Customized passwords, which have been assigned beforehand over SAMSON DeviceLink, remain unchanged and can be used to enable on-site access as well.

- A reset to default settings causes the default password to be valid again. Any configured parameters are lost.

Configuration instructions

- A pre-configured gateway can be installed without having to be configured in SAMSON DeviceLink.
- Remote configuration of the firmware is possible over SAM DISTRICT ENERGY.
- In version 1.1 and higher, it is possible to configure the device in SAMSON DeviceLink through enabling the on-site access.
- The gateway can be reset to its default settings at any time.

7.5 Enabling on-site access

Enabling on-site access is a security and authentication mechanism used for all SAM MOBILE+ Gateways. It is managed over the SAM DISTRICT ENERGY portal. It ensures that only authorized persons with physical access to the gateway are granted access over the SAMSON DeviceLink software in order to configure it.

Security features

- Protection against unauthorized remote access
- It ensures that a person is physically on site to operate the device.
- The requirements of the European Commission Delegated Regulation (EU) 2022/30, which supplements the Radio Equipment Directive, are met.

i Note

A stable mobile connection is required for it to function.

Function

1. The SAM DISTRICT ENERGY portal generates a six-figure code, which is valid for a limited period of time.
Go to: Gateway → Administration → Configuration → Settings (top-right icon) → On-site access
2. The generated code appears in the SAM DISTRICT ENERGY portal as soon as the on-site initialization of the device starts. The code is also sent to the relevant gateway over the mobile connection.
3. To access the gateway, the six-figure access code must be entered into SAMSON DeviceLink on site.
4. Access to the gateway is granted once the code has been entered correctly. All functions for configuration and parameterization are then available:
 - Gateway configuration
 - Measuring the cellular signal
 - Monitoring, diagnostics and debugging

Configuration

7.6 Resetting the gateway to default settings

The gateway can be reset to its default settings at any time. Any configured parameters are lost.

There are two ways to perform a reset:

- Load and save default settings over SAMSON DeviceLink
- Reset to default settings by jumpering two contacts (see Fig. 6)

Reset to default settings

⇒ Contact the two contacts using a conducting object until the Power LED on the gateway starts to blink quickly.

The gateway restarts.

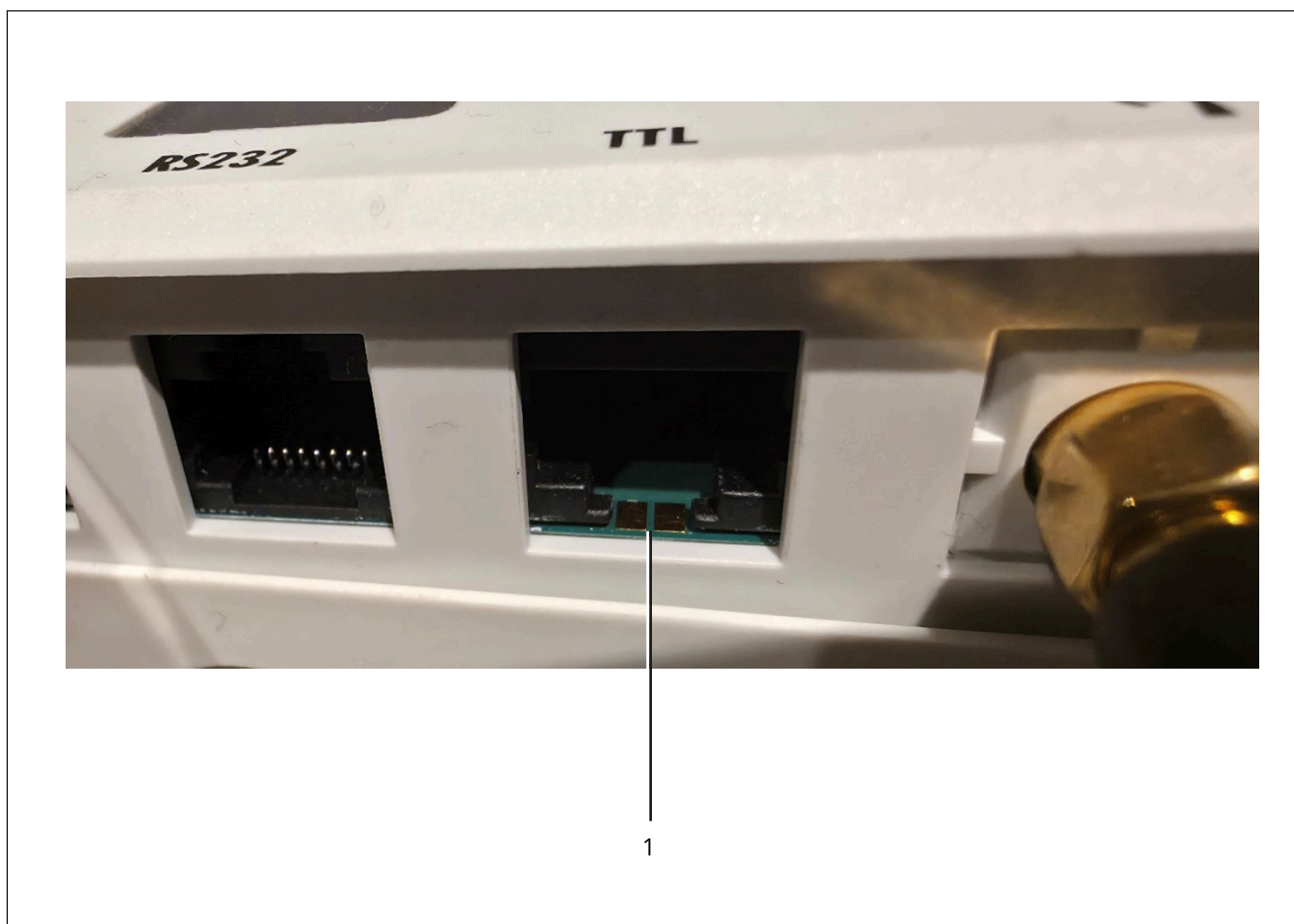

Fig. 6: Connections of the SAM Mobile+ Gateway

1 Contacts

8 Operation

Network data transmission takes place while the gateway is operating. A direct connection to the Internet is established during operation. Communication using the Modbus TCP protocol is protected against transmission errors by checksum mechanisms.

⇒ Take appropriate data security measures to prevent unauthorized access.

8.1 LED status indication

The LEDs of the gateway indicate its operating and communication states.

Table 3: Status reading of the LEDs

LED	Meaning
Red	Error
Blinking	Restricted functions
Green (permanently)	Device functioning properly
Yellow (permanently)	Device functioning properly

⇒ Blinking pattern (see Chapter 3.1 and Chapter 9.1)

9 Malfunctions

9.1 Troubleshooting











⇒ See Table 4 and Table 5.

Table 4: Troubleshooting (1)

Error	Possible reasons	Recommended action
Power LED not illuminated.	The gateway is not powered with the specified voltage supply.	⇒ Check the supply voltage (see Chapter 3 and Chapter 5).

When the supply voltage is connected, errors are indicated through the use of different blinking patterns of the **error LED**.

Table 5: Troubleshooting (2)

Blinking pattern of error LED	Error	Possible reasons	Recommended action
	Communication error – Modbus RTU (RS-232, RS-485, TTL)	Loose or defective connecting cables	⇒ Check the connecting cables. Note: After an automatic device search in the SAM DISTRICT ENERGY web portal, the status appears for a short period and goes out again after 10 minutes.
	No SIM card	While trying to connect the gateway to SAM DISTRICT ENERGY or a Modbus TCP client, no SIM card has been found in the gateway.	⇒ Insert the SIM card into the gateway and reconnect it. Note: The gateway must only be connected to SAM DISTRICT ENERGY using the SIM card supplied by SAMSON.
	SIM lock	The SIM card has been locked.	⇒ Contact SAMSON's After-sales Service.
	PIN not valid	While trying to connect the gateway to SAM DISTRICT ENERGY, it has detected that the SIM card used is not registered with SAMSON.	⇒ Contact SAMSON's After-sales Service. ⇒ If necessary, use the PUK code to reactivate the SIM card.
	Modem communication error	Modem configuration in the gateway incorrect	⇒ Check modem configuration in the gateway (SAMSON DeviceLink).
		Modem is defective	⇒ Check the gateway and contact SAMSON's After-sales Service.
	Logged into GPRS, but Internet not accessible.	No true or full Internet connection (ping request to server failed)	⇒ Restart the gateway for redialing in the mobile phone network (provider error).
	No cellular signal or weak signal	The gateway has been installed in a location where radio signals cannot be received.	⇒ Install the gateway at another location.
		Cellular signal has been interrupted	No action necessary Once the cellular signal is available again, the gateway automatically reconnects to SAM DISTRICT ENERGY or the Modbus TCP client.
	Meter bus communication error	Connected M-Bus device is defective	⇒ Check the M-Bus device.
	Meter bus meter error	Meter configuration in the gateway is incorrect	⇒ Check meter configuration in the gateway (SAMSON DeviceLink).
		Connected meter is defective	⇒ Check meter.
	Connection to web portal not possible	SAM DISTRICT ENERGY is offline (e.g. due to maintenance work).	No action necessary As soon as SAM DISTRICT ENERGY is online again, the gateway automatically reconnects.

Blinking pattern of error LED	Error	Possible reasons	Recommended action
	No valid ZBD file exists	A corrupt file or no file has been loaded.	⇒ Contact SAMSON's After-sales Service.
	Modbus TCP forwarding	Error during Modbus TCP forwarding in the gateway or the Modbus TCP server cannot be reached as a participant (e.g. controller)	⇒ Check the Ethernet/broadband wiring. ⇒ Check configuration settings in the gateway (SAMSON DeviceLink).

Legend

- LED long ON
- LED short ON

i Note

Contact SAMSON's After-sales Service for malfunctions not listed in the table.

9.2 Emergency action

Plant operators are responsible for emergency action to be taken in the plant.

10 Servicing

The work described in this chapter is to be performed only by personnel appropriately qualified to carry out such tasks.

SAMSON recommends inspection and testing according to Table 6.

Table 6: *Recommended inspection and testing*

Inspection and testing	Action to be taken in the event of a negative result
Check the markings, labels and nameplates on the gateway for their readability and completeness.	⇒ Immediately renew damaged, missing or incorrect nameplates or labels. ⇒ Clean any inscriptions that are covered with dirt and are illegible.
Check the electric wiring.	⇒ Tighten any loose terminal screws (see Chapter 5). ⇒ Renew damaged wires.

11 Decommissioning

The work described in this chapter is to be performed only by personnel appropriately qualified to carry out such tasks.

⚠ DANGER***Risk of fatal injury due to electric shock.***

⇒ *Before disconnecting live wires at the device, disconnect the supply voltage and protect it against unintentional reconnection.*

⇒ Disconnect the supply voltage and protect it against unintentional reconnection.

Removal

12 Removal

The work described in this chapter is to be performed only by personnel appropriately qualified to carry out such tasks.

⚠ DANGER

Risk of fatal injury due to electric shock.

⇒ *Before disconnecting live wires at the device, disconnect the supply voltage and protect it against unintentional reconnection.*

1. Undo and remove the screws on the front cover.
2. Carefully pull the gateway device off the base.
3. Remove the PCB on which the SIM card is mounted.
4. Check that the actuator is de-energized.
5. Disconnect the wires (supply voltage) at terminals 18 and 19.
6. Disconnect all wires of the externally fed cables from the terminals.
7. Remove grommets or cable glands fitted at the cable entry and pull the cables out of the terminal compartment.

Panel mounting

⇒ Push the base through the panel cut-out.

Rail mounting

⇒ Slightly push the base upwards, pull the top hook out of the top hat rail and remove the base.

Wall mounting

⇒ Undo and remove the screws.

⇒ Remove the base.

13 Repairs

A defective gateway must be repaired or replaced.

NOTICE

Risk of gateway damage due to incorrect service or repair work.

- ⇒ *Do not perform any repair work on your own.*
- ⇒ *Contact SAMSON's After-sales Service for service and repair work.*

13.1 Returning devices to SAMSON

Defective gateways can be returned to SAMSON for repair.

Proceed as follows to return devices to SAMSON:

1. Put the gateway out of operation (see Chapter 11).
2. Remove the gateway (see Chapter 12).
3. Proceed as described on the Returning goods page of our website (► www.samsongroup.com > SERVICE > After-sales Service > Returning goods).

Disposal

14 Disposal



SAMSON is a producer registered in Europe, agency in charge

► www.samsongroup.com > About SAMSON > Environment, Social & Governance > Material Compliance > Waste electrical and electronic equipment (WEEE)
WEEE reg. no.: DE 62194439

Information on substances listed as substances of very high concern (SVHC) on the candidate list of the REACH regulation can be found in the document "Additional Information on Your Inquiry/Order", which is added to the order documents, if applicable. This document includes the SCIP number assigned to the devices concerned. This number can be entered into the database on the European Chemicals Agency (ECHA) website (► <https://www.echa.europa.eu/scip-database>) to find out more information on the SVHC contained in the device.

i Note

SAMSON can provide you with a recycling passport on request. Simply e-mail us at aftersaleservice@samsongroup.com giving details of your company address.

💡 Tip

On request, SAMSON can appoint a service provider to dismantle and recycle the product as part of a distributor take-back scheme.

- ⇒ Observe local, national and international refuse regulations.
- ⇒ Do not dispose of components, lubricants and hazardous substances together with your other household waste.

15 Certificates

The following certificate is shown on the next page:

- EU declaration of conformity

The certificate shown was up to date at the time of publishing. The latest certificate can be found on our website at:

The latest certificates can be found on our website:

▶ www.samsongroup.com > Products > Automation systems > SAM MOBILE+ Gateway

EU-DECLARATION OF CONFORMITY

TRANSLATION



This declaration of conformity is issued under the sole responsibility of the manufacturer.

Manufacturer:

SAMSON AKTIENGESELLSCHAFT
Weismüllerstraße 3
60314 Frankfurt am Main
Deutschland

Product designation:

SAM MOBILE+ Gateway Type 5656

The product described above is in conformity with the relevant Union harmonisation legislation:

EU Directive	Standards / Technical Specifications
2014/30/EU	EN 61000-6-1:2007, EN IEC 61000-6-1:2019 EN 61000-6-3:2007/A1:2011, EN IEC 61000-6-3:2021 EN 61000-6-4:2007/A1:2011, EN IEC 61000-4:2018 EN 55032:2015/A11:2020 EN 301 489-1 V1.9.2, EN 301 489-1 V2.2.3 (2019-11) EN 301 489-52 V1.2.1 (2021-11)
2014/34/EU	EN 62368-1:2014/AC:2015 EN IEC 62368-1:2024 + A11:2024 EN 60730-1:2011 EN 60730-1:2016 + A1:2019 + A2:2022 + A11:2024
2014/53/EU	EN 301 908-X
2011/65/EU	EN IEC 63000:2018

Signed for and on behalf of:

Frankfurt am Main, 2026-04-02



ppa. Sebastian Krause
Vice President Product Development



i.V. Marc Belzer
Director Product Management

16 Appendix

16.1 Accessories

Designation	Description	Order no.
SA5000	Surge arrester for two-wire RS-485 bus systems	1400-9868
SACO55	Surge arrester with integrated two-wire RS-232 to RS-485 converter	1400-9771
iCon485	Adapter to connect TROVIS 5573 or TROVIS 5578 Heating and District Heating Controller to a RS-485 bus	8812-2002
CoRe02	Converter/repeater or RS-232 or RS-485 interface	1400-9670
SAM DISTRICT ENERGY	Connection of TROVIS (heating) controllers to the web portal	900000131
SAM DISTRICT ENERGY	Connection of utility meters to the web portal	900000130
SAM DISTRICT ENERGY	Connection of Type 3374 Electric Actuators to the web portal	900000269
SAM DISTRICT ENERGY	Connection of TROVIS 5724-8 and TROVIS 5725-8 Electric Actuators with Process Controller to the web portal	900000266
Antenna with magnetic base (SMA)	2.5 m cable length	1402-0853
Antenna with magnetic base (SMA)	5 m cable length	1402-0852
Antenna with magnetic base (SMA)	10 m cable length	1402-1908
Rod antenna (SMA)	Multi-band	1402-0854
Configuration software	Link for download: ► SAMSON DeviceLink	

16.2 After-sales service

Contact our after-sales service for support concerning service or repair work or when malfunctions or defects arise.

► aftersaleservice@samsongroup.com

The addresses of SAMSON AG, its subsidiaries, representatives and service facilities worldwide can be found on our website (► www.samsongroup.com) or in all product catalogs.

Please submit the following details:

- Type designation
- Serial number
- Firmware version

Default password

User

Admin

Password

Kundendienst



SAMSON AKTIENGESELLSCHAFT
Weismüllerstraße 3 · 60314 Frankfurt am Main, Germany
Phone: +49 69 4009-0 · Fax: +49 69 4009-1507
samson@samsongroup.com · www.samsongroup.com